

## **Circuit Protection Devices for Medical Equipment**



# E-T-A, Setting the Pace for Circuit Protection

Since 1948, the E-T-A registered mark has been recognized as a symbol of safety and reliability throughout the field of equipment protection. With headquarters in Altdorf, Germany, E-T-A is an international group of companies and a world leader in the design, development, and manufacturing of circuit breakers for the protection of components, equipment, and systems against overload and short circuit.

## Thermal Products | [Page 04](#)

(Thermal Reset Circuit Breakers and Thermal Circuit Breaker and Switch Combinations)

104	1410 L/G	3130
105	1658	X3130 PEM
106	2-5700	3140
1110	3120	4130
1115	X3120 PEM	
1140	X3120 PEM Filtered	

## Thermal-Magnetic Products | [Page 08](#)

201	2210-S (17 Plus Socket)	3300/3400
2210-T	2216 (80/81 Sockets)	4230

## Magnetic and Hydraulic-Magnetic Circuit Breakers | [Page 10](#)

808	8335
8330	8350

## Solid State Products | [Page 12](#)

ESX10 (17 Plus Sockets)	ESS30 (17/18 Plus Sockets)	REF16 (80/81 Plus Sockets)
ESX10-T	REX12-T	

### Typical Medical Applications

Anesthesia equipment	Motorized chair lifts
CT Scanners	Operating microscopes
Dentist chairs	Patient lifts
Electric wheelchairs	Respirators
Endoscopes	Stair lifts
Hospital Beds	Sterilization baths
Incubators	Suction machines/aspirators
Laboratory centrifuges	Surgical operating lamps
Laboratory thermostats	Surgical robots
Laser machines	Treadmills
Magnetic Resonance Imaging	Ultrasonic test instruments
Medical chillers	Ventilators
Medical warming ovens	X-ray apparatus

# Professional protection of medical equipment

## Selective individual protection

In devices and machines with several loads, it is often necessary to protect these loads selectively in addition to the collective protection on the input side. It is the only way to realize a professional overload protection that is ideally and reliably rated for loads such as electric motors and transformers.

## Collective protection on the input side

Mobile and semi-stationary devices and machines generally have a plug (mains plug or inlet plug) for connection to the AC network. In the event of a failure, circuit breakers installed on the input side immediately after the plug will disconnect the entire device or the entire machine from the mains power supply.



## Selective protection of DC 24 V loads

DC 24 V loads in stationary devices and machines today are normally supplied by primary pulsed switch mode power supplies. E-T-A circuit breakers provide selective overcurrent protection.

## Protection of printed circuit boards

Printed circuit boards in stationary and semi-stationary devices and machines often require an additional fast-acting overcurrent protection due to their very sensitive semi-conductor components.

# Thermal Products

(Thermal Reset Circuit Breakers; Thermal Circuit Breaker and Switch Combinations)

Trip time of thermal circuit breakers depends on the overload current. The higher the current, the faster the bimetal will reach its predetermined tripping temperature. Therefore, they are ideally suited to the protection of motors, transformer windings and low voltage power distribution circuits in medical equipment.

E-T-A thermal circuit breakers can quickly be reset manually after tripping. With tease-free and trip-free trip mechanisms, thermal circuit breakers provide extremely reliable and robust interrupting capacity, and ensure reduced





downtime and increased longevity of medical apparatus and equipment.

Are reliable and cost-effective designs important to you? Thermal overcurrent protection circuit breakers can be combined with on/off switch function for use in various medical applications. Alternatively to where fuses, fuse holders, separate switches or press to reset only circuit breakers are used, E-T-A's multi-functional products will significantly reduce the number of components required in assembly for saving space, time and overall design and manufacturing costs.







E-T-A offers the 3120-N in a choice of single and multi-pole versions with rocker or push button actuation. Rocker actuators are available in non-lighted or lighted, in various colors and imprinting options along with protective rocker guard and optional IP65 water splash protection. Push button choices include the traditional red/green two button as well as a unique offering of protection from accidental operation where the breaker can't be turned on even if you engage the actuator.







# Thermal Products Selection Chart

Thermal Products		104	105	106	1110	1115
Photos						
Number of Poles		1	1	1	1	1
Rated Voltage		AC 250V; DC48V	AC 250V; DC48V	AC 250V; DC48V	AC 250V; DC 50V	AC 250V; DC 32
Current Range		0.05 - 10A	0.05 - 10A	0.05 - 10A	0.05 - 16A	1 - 16A
Applications	Surgical Devices	•	•	•	•	•
	Imaging & Scanners	•	•	•	•	•
	Patient Mobility Equipment			•	•	•
	Operating Room Apparatus	•	•	•	•	•
	Dental Equipment		•	•	•	•
Actuator Type	Press to reset	•	•	•		•
	Rocker					
	Push On -Push Off				•	
	Push / Pull					
	Push Button					
	Toggle					
Options	IP Protection			•	•	•
	Remote Tripping					
	Aux Contact	•				
	Illumination					
	Undervoltage Protection					
Mounting	Thread Neck			•		
	Snap in Front		•		•	•
	Snap in Back					
	Flange					
	PCB, THT	•				
	Din Rail Mount					
Connections	Quick Connect / Blade Type	•	•	•	•	•
	Screw Terminal					
	Solder Terminal	•				
	Pluggable					
	Stud Terminals					
	Push - in Terminal					

# Thermal Products Selection Chart

Thermal Products		1140	1410 L/G	1658	2-5700	3120	X3120
Photos							
Number of Poles		1	1	1	1	1 & 2	1 & 2
Rated Voltage		AC 250V; DC 50V	AC 250V; DC 50V	AC 250V; DC 28 / 32	AC 250V; DC 80V	AC 250V; DC 50V	AC 250V; DC 50V
Current Range		3.5 - 16A	0.63 - 10A	5 - 30A	0.05 - 25A	0.1 - 20A	0.1 - 20A
Applications	Surgical Devices	•	•	•	•	•	•
	Imaging & Scanners	•	•	•	•	•	•
	Patient Mobility Equipment	•		•	•	•	•
	Operating Room Apparatus	•	•	•	•	•	•
	Dental Equipment	•		•	•	•	•
Actuator Type	Press to reset	•	•	•	•	•	•
	Rocker					•	•
	Push On - Push Off				•		
	Push / Pull						
	Push Button					•	
	Toggle						
Options	IP Protection	•		•	•	•	•
	Remote Tripping					•	•
	Aux Contact		•			•	•
	Illumination					•	•
	Undervoltage Protection					•	•
Mounting	Thread Neck	•	•	•	•		
	Snap in Front					•	•
	Snap in Back			•			
	Flange						•
	PCB, THT		•	•			
	Din Rail Mount						
Connections	Quick Connect / Blade Type	•		•	•	•	•
	Screw Terminal			•	•	•	•
	Solder Terminal		•	•			
	Pluggable						
	Stud Terminals						
	Push - in Terminal					•	•

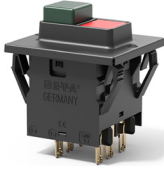
# Thermal Products Selection Chart

Thermal Products		X3120 PEM	3130	X3130 PEM	3140	4130
Photos						
Number of Poles		1 & 2	1, 2 & 3	2	3 & 4	1
Rated Voltage		AC 250V; DC 50V	AC 250V; 3 AC 415V; DC 50V	AC 250V; DC 50V	3 AC 415V; DC 50	AC 240V; DC 50V
Current Range		0.1 - 20A	0.1 - 20A	0.1 - 15A	0.1 - 16A	20 - 80A
Applications	Surgical Devices	<input checked="" type="checkbox"/>	<input checked="" type="checkbox"/>	<input checked="" type="checkbox"/>	<input checked="" type="checkbox"/>	<input checked="" type="checkbox"/>
	Imaging & Scanners	<input checked="" type="checkbox"/>	<input checked="" type="checkbox"/>	<input checked="" type="checkbox"/>	<input checked="" type="checkbox"/>	<input checked="" type="checkbox"/>
	Patient Mobility Equipment	<input checked="" type="checkbox"/>	<input checked="" type="checkbox"/>	<input checked="" type="checkbox"/>		<input checked="" type="checkbox"/>
	Operating Room Apparatus	<input checked="" type="checkbox"/>	<input checked="" type="checkbox"/>	<input checked="" type="checkbox"/>	<input checked="" type="checkbox"/>	<input checked="" type="checkbox"/>
	Dental Equipment	<input checked="" type="checkbox"/>	<input checked="" type="checkbox"/>	<input checked="" type="checkbox"/>	<input checked="" type="checkbox"/>	<input checked="" type="checkbox"/>
Actuator Type	Press to reset	<input checked="" type="checkbox"/>				<input checked="" type="checkbox"/>
	Rocker	<input checked="" type="checkbox"/>	<input checked="" type="checkbox"/>	<input checked="" type="checkbox"/>		
	Push On - Push Off					
	Push / Pull					
	Push Button				<input checked="" type="checkbox"/>	
Toggle						
Options	IP Protection	<input checked="" type="checkbox"/>	<input checked="" type="checkbox"/>	<input checked="" type="checkbox"/>	<input checked="" type="checkbox"/>	<input checked="" type="checkbox"/>
	Remote Tripping	<input checked="" type="checkbox"/>				
	Aux Contact	<input checked="" type="checkbox"/>				
	Illumination	<input checked="" type="checkbox"/>	<input checked="" type="checkbox"/>	<input checked="" type="checkbox"/>		
	Undervoltage Protection	<input checked="" type="checkbox"/>			<input checked="" type="checkbox"/>	
Mounting	Thread Neck					<input checked="" type="checkbox"/>
	Snap in Front	<input checked="" type="checkbox"/>	<input checked="" type="checkbox"/>		<input checked="" type="checkbox"/>	
	Snap in Back					
	Flange	<input checked="" type="checkbox"/>		<input checked="" type="checkbox"/>		
	PCB, THT					
	Din Rail Mount					
Connections	Quick Connect / Blade Type	<input checked="" type="checkbox"/>	<input checked="" type="checkbox"/>	<input checked="" type="checkbox"/>	<input checked="" type="checkbox"/>	
	Screw Terminal	<input checked="" type="checkbox"/>	<input checked="" type="checkbox"/>	<input checked="" type="checkbox"/>	<input checked="" type="checkbox"/>	<input checked="" type="checkbox"/>
	Solder Terminal					
	Pluggable					
	Stud Terminals					
	Push - in Terminal	<input checked="" type="checkbox"/>				

# Thermal-Magnetic Products

Thermal-magnetic circuit breakers typically feature a latching type bimetal combined in series with a solenoid to provide the benefits of both a delayed operation for low level over current protection and a faster response to higher value overloads.





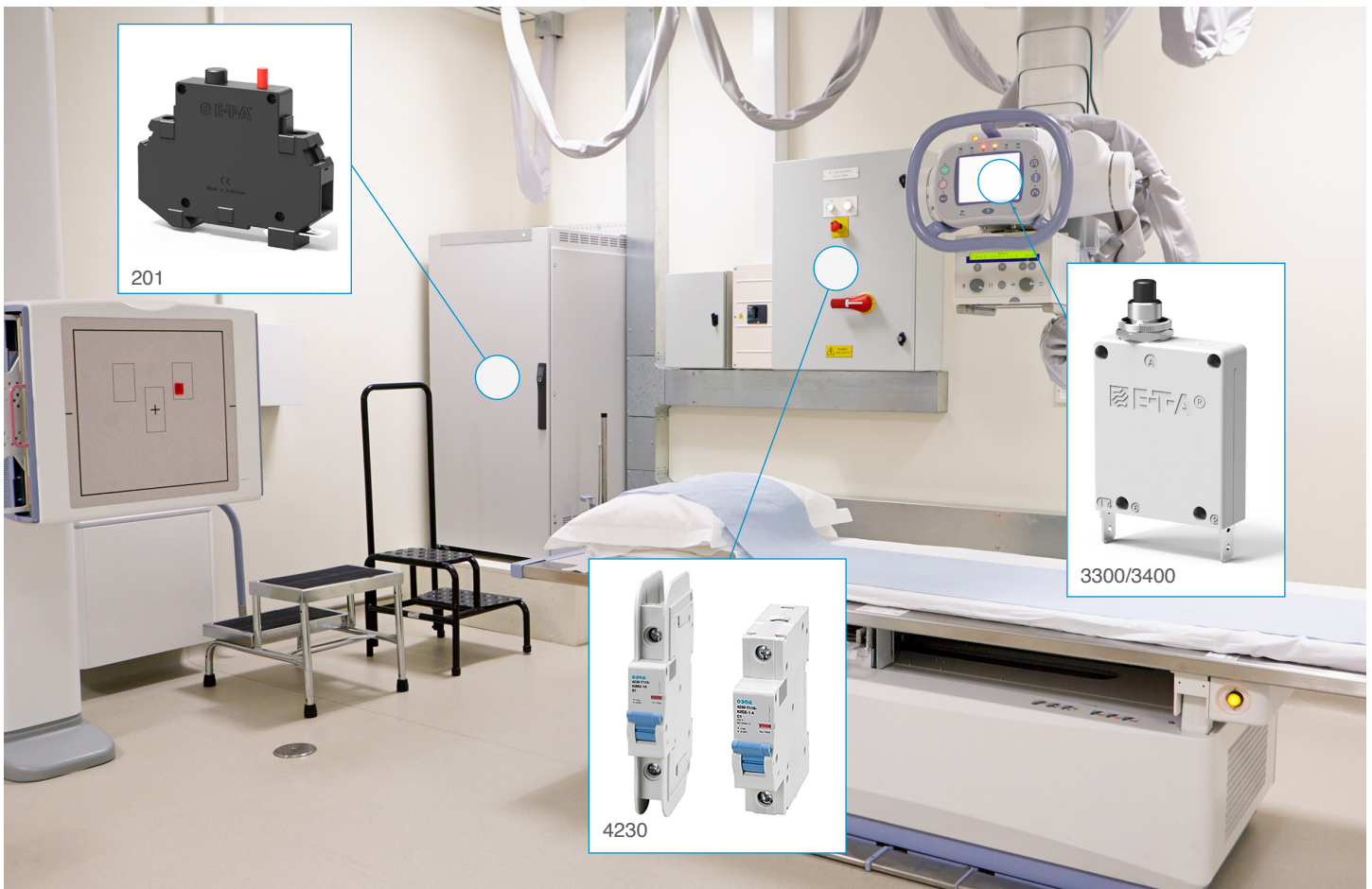

While a Thermal device provides ideal protection for nominal over currents experienced over time, the energized solenoid of the Magnetic feature will provide a more rapid response to more significant over currents exceeding 5-6 times the current rating of the circuit breaker.

If your application requires both instantaneous and time-delayed protection our range of thermal magnetic breakers may be the solution you require. Available in 1 to 4 pole , din rail mounting and ratings up to 63A.





# Thermal-Magnetic Products Selection Chart

Thermal-Magnetic Products		201	2210-T	2210-S (17 Plus Socket)	2216 (80 / 81 Sockets)	3300/3400	4230
Photos							
Number of Poles		1&2	1, 2 &3	1, 2 & 3	1 & 2	1	1, 2, 3, 4
Rated Voltage		AC 120/240; DC 80V	AC 120-240/480; DC 65V	AC 120-240/480; DC 65V	AC 240V; DC 50/80	AC 250; DC 80V	AC 480/Y277; DC 60/125V
Current Range		0.05 - 16A	0.1 - 32A	0.1 - 32A	0.5 - 16A	0.05 - 16A	1 - 63A
Applications	Surgical Devices					•	
	Imaging & Scanners	•	•	•	•	•	•
	Patient Mobility Equipment					•	
	Operating Room Apparatus		•	•	•	•	•
	Dental Equipment					•	
Actuator Type	Press to reset					•	
	Rocker						
	Push On - Push Off						
	Push / Pull					•	
	Push Button	•					
	Toggle		•	•	•		•
Options	IP Protection					•	
	Remote Tripping						
	Aux Contact		•	•	•	•	•
	Illumination						
	Undervoltage Protection						
Mounting	Thread Neck					•	
	Snap in Front						
	Snap in Back						
	Flange			•			
	PCB, THT						
	Din Rail Mount	•	•	•	•		•
Connections	Quick Connect / Blade Type		•		•	•	•
	Screw Terminal	•	•		•	•	•
	Solder Terminal					•	
	Pluggable			•	•		
	Stud Terminals						
	Push - in Terminal						

# Magnetic/Hydraulic-Magnetic Products

Hydraulic-magnetic circuit breakers include a main contact assembly which is held in the closed position by a spring loaded mechanical latching mechanism. This mechanism is triggered by operation of a solenoid which is energized when the current reaches or exceeds a predetermined point. By utiliz-





ing the available delay curves of short, medium or long the design engineer can tailor the breaker to meet the specific application.

The fast switching characteristic of a Magnetic design provides protection of printed circuit boards and semi-con-

ductors. As a temperature stable device they are not appreciably affected by changes in ambient temperature and can be reset immediately after tripping. Available in 1 to 4 pole with ratings up to 125A they provide ideal solutions for many medical applications.



# Magnetic/Hydraulic-Magnetic Products Selection Chart

Magnetic/Hydraulic Products		808	8330	8335	8350
Photos					
Number of Poles		1	1 & 2	1, 2 & 3	1, 2, 3, 4
Rated Voltage		AC 120V; DC 24V	AC 125/250V; DC 80V	3 AC 415V AC 250V; DC 80V	3 AC 415V AC 250 V; DC 80V
Current Range		0.01 - 5A	0.1 - 30A	1 - 50A	0.1 - 100A
Applications	Surgical Devices	•	•	•	•
	Imaging & Scanners	•	•	•	•
	Patient Mobility Equipment		•	•	•
	Operating Room Apparatus	•	•	•	•
	Dental Equipment		•	•	•
Actuator Type	Press to reset		•		
	Rocker		•	•	•
	Push On -Push Off				
	Push / Pull	•	•		
	Push Button				
	Toggle		•	•	•
Options	IP Protection			•	•
	Remote Tripping				
	Aux Contact	•		•	•
	Illumination		•		
	Undervoltage Protection				
Mounting	Thread Neck		•		
	Snap in Front		•	•	•
	Snap in Back		•		
	Flange			•	•
	PCB, THT	•			
	Din Rail Mount				
Connections	Quick Connect / Blade Type		•	•	•
	Screw Terminal		•	•	•
	Solder Terminal	•			
	Pluggable				
	Stud Terminals				•
	Push - in Terminal				

## Solid State Products

In large medical equipment, 24 V DC switch-mode power supplies (SMPS) are used more and more frequently, replacing conventional transformer power supplies. The requirements of SMPS regarding overcurrent protection are quite different – at high loads caused by short circuit or overload,





an SMPS will automatically reduce its output voltage.

E-T-A's solid state electronic circuit breakers and protectors provide the ideal solution for this challenge. Thanks to integral current limitation, they ensure reliable selective load disconnec-

tion. In the event of an overcurrent in a load circuit, only the faulty circuit will be disconnected, without affecting the 24 VDC switch-mode power supply. Selective disconnection ensures that important parts of the system stay in operation.



# Solid State Products Selection Chart

Solid State Products		ESX10 (17 Plus Sockets)	ESX10-T	ESS30 (17 / 18 Plus Sockets)	REX12-T	REF16 (80 / 81 Plus Sockets)
Photos						
Number of Poles		1	1	1	1 or 2	1
Rated Voltage		DC 24V	DC 12-24-48	DC 24V	DC 24V	DC 24V
Current Range		0.5 -16A	0.5-25A	0.5 -12A	1A - 10A	0.5 - 10A
Applications	Surgical Devices					
	Imaging & Scanners	•	•	•	•	•
	Patient Mobility Equipment					
	Operating Room Apparatus	•	•	•	•	•
	Dental Equipment					
Actuator Type	Press to reset					
	Rocker					
	Push On - Push Off					
	Push / Pull					
	Push Button	•	•	•	•	•
	Toggle					
Options	IP Protection					
	Remote Tripping					
	Aux Contact	•	•	•	•	•
	Illumination					
	Undervoltage Protection					
Mounting	Thread Neck					
	Snap in Front					
	Snap in Back					
	Flange					
	PCB, THT					
	Din Rail Mount	•	•	•	•	•
Connections	Quick Connect / Blade Type					
	Screw Terminal	•		•		•
	Solder Terminal					
	Pluggable	•		•		•
	Stud Terminals					
	Push - in Terminal					

# Custom Power Management Solutions

Power solutions begin with an understanding of the customer's requirements. From concept to production, E-T-A is equipped with the expertise and tools necessary to develop, produce, and test power solutions that meet and exceed the specifications of the customer's application. Each project is managed through our ISO certified product development process to ensure the highest level of quality through all stages of the design cycle. With a comprehensive design team and vast design capabilities available E-T-A power solutions are comprised of three major disciplines:

## Mechanical Design

E-T-A uses professional 3D CAD software to provide complex and efficient housing design, connection technology, cable management, busbar design, and power circuit protection design and switching. Computational Flow Dynamic (CFD) software is used to analyze

designs that may be deployed in harsh environments to ensure extended life of the product and quality.

## Hardware Design

Utilizing the latest state of the art technology, E-T-A provides printed circuit board design and layout, user interfaces, and various processes for connecting components on the printed circuit board such as Press-fit technology, THT soldering (selective or wave soldering), and SMT soldering.

## Software Design

Smart distribution requires a complex software layer for monitoring and control. E-T-A uses operating systems such as Linux and programming languages Python, C++, etc. to design effective networks for the monitoring and control layer. CAN bus, PROFINET, Modbus, Ethernet/IP, ELBUS are several communication standards that E-T-A designs into our products.

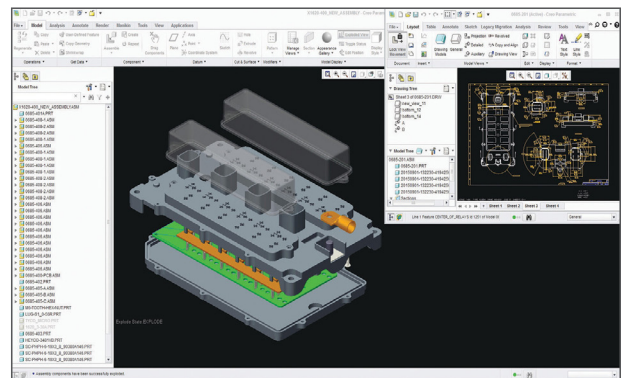
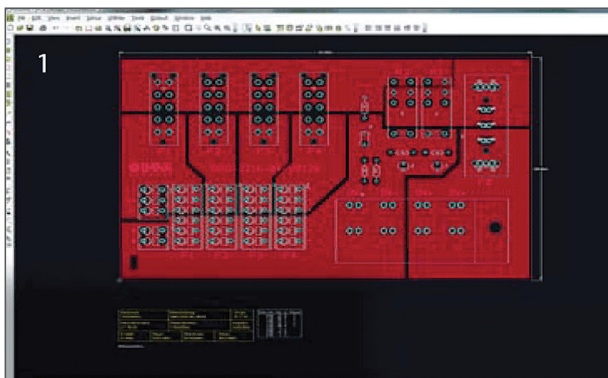
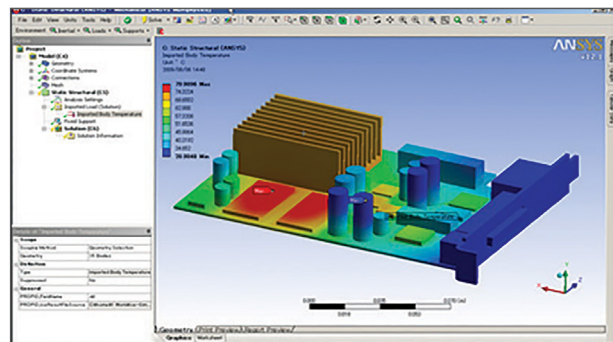
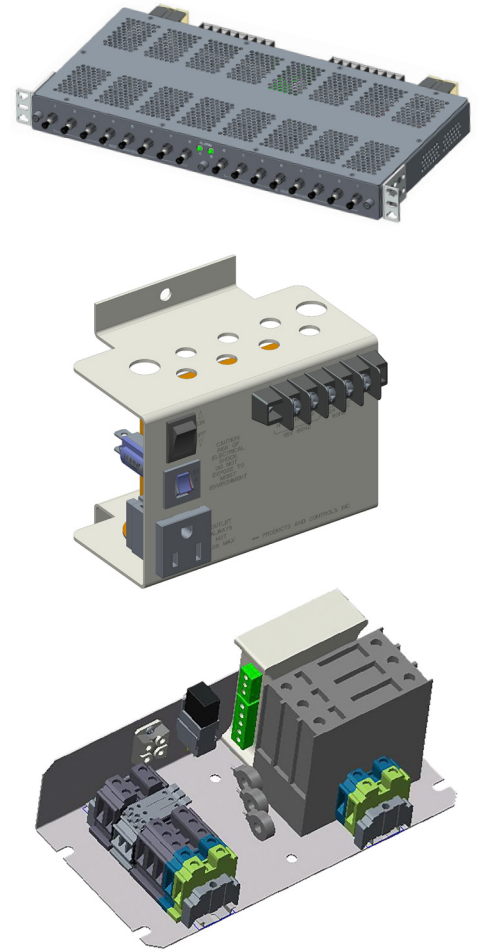



ENGINEERING TECHNOLOGY

**E-T-A Apparecchi Elettrotecnici s.r.l.**  
Via Ludovico Di Breme Nr. 50/F  
20156 MILANO  
Tel.: +39 02 33496444 . Fax: +39 02 33406767  
E-Mail: [info@e-t-a.it](mailto:info@e-t-a.it) . [www.e-t-a.it](http://www.e-t-a.it)